



March 24-26, 2023

# Experiments With Unusual Materials for Magnetic Loop Antennas

*John Portune / W6NBC*



*This loop is an  
unfinished experiment*

***I DON'T HAVE BUILD-IT PLANS***

*Many details are still to be worked out*

**I do, therefore, want your suggestions**

**w6nbcmail@gmail.com**

**Power Point Slides: [w6nbc.com/slides](http://w6nbc.com/slides)**



# A SURPRISE

*Copper pipe  
work well  
for mag loops*

But it isn't  
**OPTIMAL** or  
*necessary*

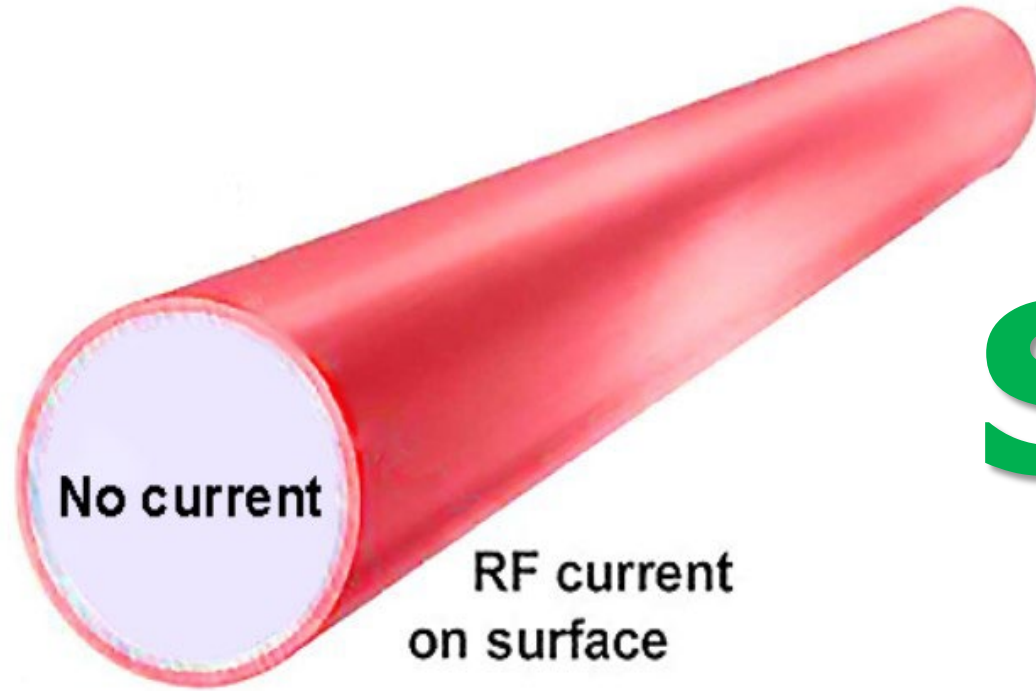

**WHY?**

# Skin Effect

**The center of  
the conductor  
isn't needed**

# More Optimal Materials



**A Common Question**

**Are There Other  
Materials ?**

# MG Chemicals Shielding Paints

Copper/Silver

Nickel



# Copper Nickel



# Conductive Fabric

Soft Conductive Copper Nickel Plated Electricity Magnetic RF Shielding Fabric for Smart Meters 39"x43"

Visit the Amradiel Store

★★★★☆ 38 ratings | 17 answered questions

\$13<sup>99</sup>

≈ 0 Ω → Ohmmeter

✓prime

FREE Returns

Size: Width 43" inch / Length 39" inch

<p>Width 43" inch / Length 39" inch</p> <p><b>\$13.99</b></p> <p>✓prime</p>
---

<p>Width 43" inch / Length 78" inch</p> <p>\$24.99</p> <p>✓prime</p>
--

<p>Width 43" inch / Length 197" inch</p> <p>\$62.99</p>
---

<p>50 meters long</p> <p>\$600.00</p>
---------------------------------------

<p>100 meters long</p> <p>\$1,100.00</p>
--

Material	Nickel+copper+polyester
Color	Silver
Fabric Type	Polyester



**4 ft. square  
optimized  
PVC & foil  
mag loop**

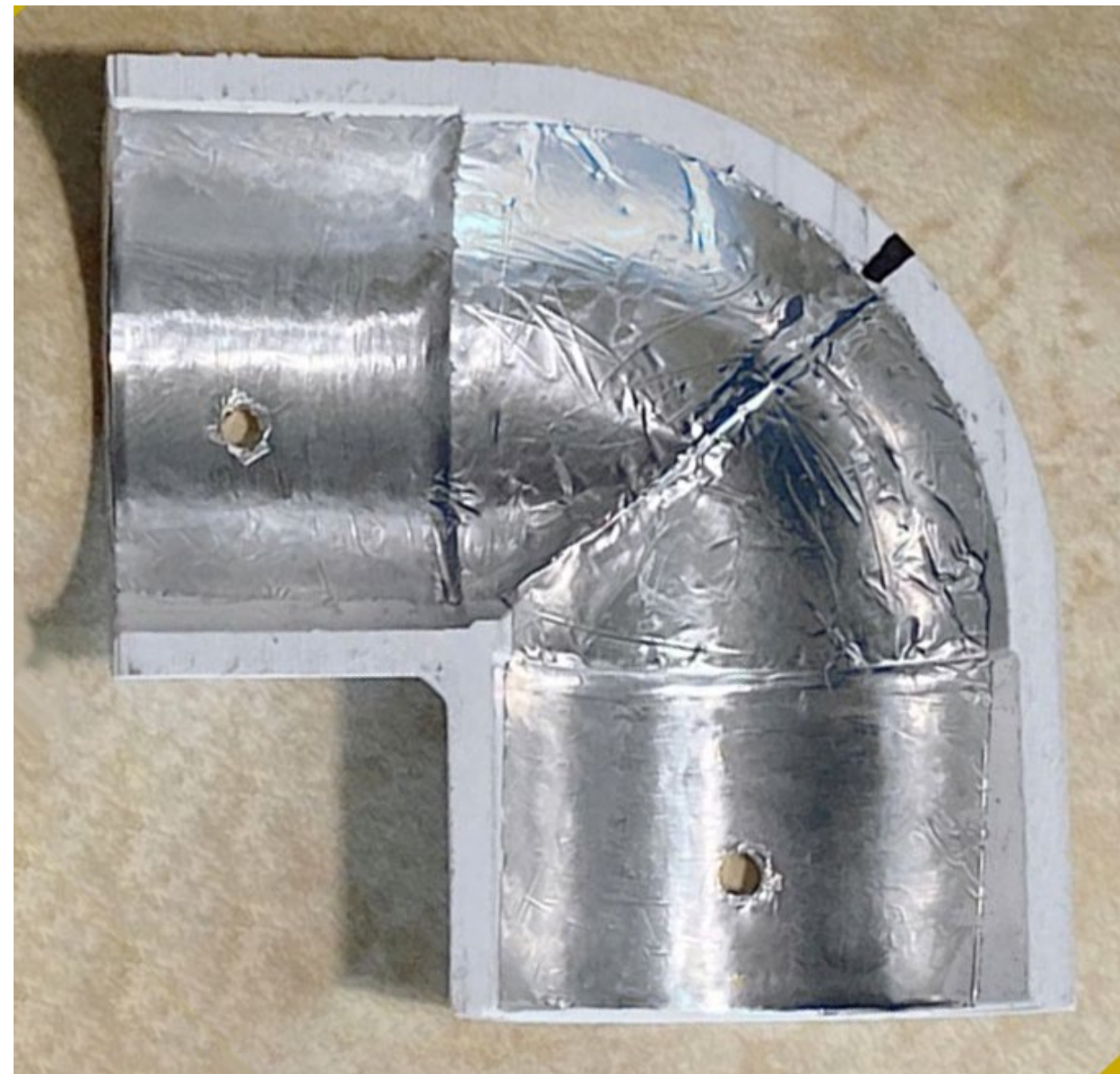

# Mission Darkness TitanRF Faraday Tape High-Shielding Conductive Adhesive Tape Roll Used to Connect TitanRF Fabric Sheets or Seal RF Enclosures



<b>1in x 10ft</b> <b>\$10.00</b> <b>(\$1.00 / Foot)</b>	1in x 164ft \$96.00 (\$0.59 / Foot)	2.5in x 10ft \$20.00 (\$2.00 / Foot)	2.5in x 164ft \$200.00 (\$1.22 / Foot)	10in x 10ft \$45.00 (\$4.50 / Foot)
---	---	--	--	---



MISSION DARKNESS  
TITANRF RADIATION  
SHIELDING THROW BLANKET

\$ 150



MISSION DARKNESS  
FREEROAM FARADAY BELT  
BAG

\$ 60



MISSION DARKNESS EMF  
BLACKOUT BEANIE

\$ 80



# Faraday Curtains

**Shielding  
Noise: In/Out**





Brand: Beistle  
Foil Cone Hat  
\$9.99



Joylife Metallic Bucket Hat  
Amazon Prime \$14.99



Brand: Generic  
Tin Foil Hat for Conspiracy Theorists  
Price: \$34.99  
Color: White  
Size: Select Size  
Size Chart  
Product Details  
Fabric Type  
Fit Type  
Pattern





**Stainless  
Steel**

**Conductive  
Yarns**



*Experimental*  
**Magnetic Loop**

**For Portable Operation**

# HF Mountain Toppers, RV'ers, Portable

Radios

Portable Power

Computers

Antennas – **A problem**

→ Small Whip? Wire over bush ?





# Magnetic Loop?

- Small
- High Performance

Can it be made ?

- **Light** enough
- **Portable** enough



**POSSIBLE,  
with the right  
Materials**



**Mountain Bike Inner  
tube  
29 x 2.5-3 in.**



**Easily inflates  
to 3 ft. x 4 in.**

**Add a  
Conductive  
Fabric casing  
and  
a break-down  
PVC Stand**

# Ready for Transport





## Bell AirStrike CO2 Bicycle Tire Inflator

[Visit the Bell Store](#)

★★★★☆ 18 ratings

\$13<sup>59</sup>

List Price: \$19.49 ⓘ

✓prime

Get a **\$100 Amazon.com Gift Card** upon approval for the Amazon Business American Express Card. Terms apply.

- Any Valve Pump Head allows you to easily connect to Presta or Schrader Valves without an adaptor, just press on to any valve
- The Bell CO2 inflator is a fast and easy way to inflate any bike tires while on the road or trail
- One 16g threaded cartridge included - one cartridge can inflate a completely flat tire
- Fits in jersey pocket or bike bag

🗨 [Report incorrect product information.](#)



Gorilla Force, Value Pack 16g Threaded CO2 Cartridges, Fits All Bike Tire Inflators

★★★★☆ 3,155

\$12.99 ✓prime

# Sewing Pattern

**1 in. rip-stop nylon gap for tuning capacitor (width not critical)**

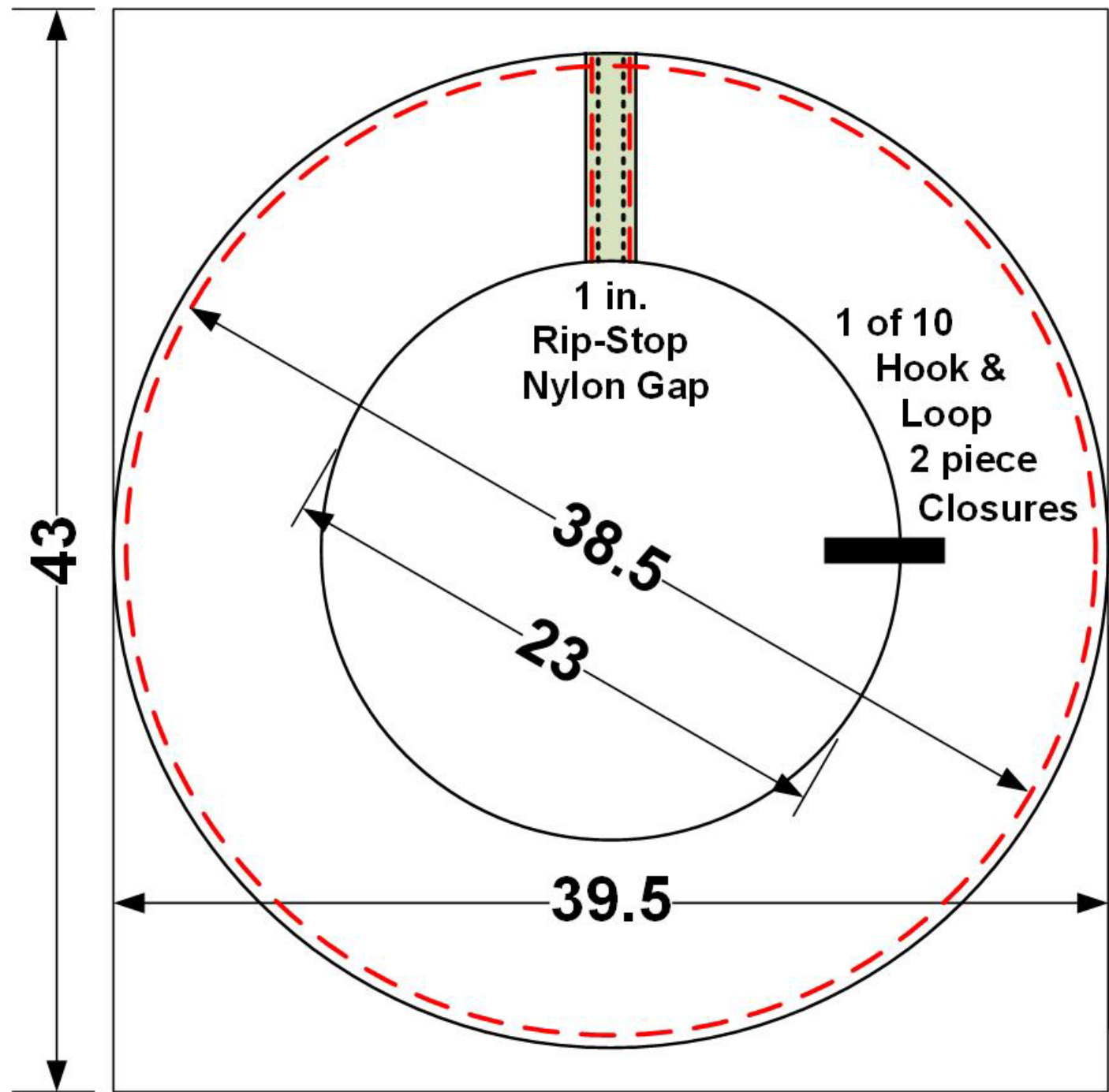



**Corrugated  
box cardboard  
half circle  
fabric making  
template**



**Marked,  
pre-trimmed,  
taped or  
pinned fabric  
layers ready  
for sewing**



# Coats & Clark Dual Duty XP Heavy 125 YD Black Polyester

Brand: Coats

**#14/16 machine needle**



| 37 answered questions

\$4<sup>81</sup> (\$0.01 / Foot)

✓prime

FREE Returns ▾

Save up to 6% with business pricing. Sign up for free Amazon Business account

Eligible for **amazon**smile donation.



# 10 Hook & Loop Loop (Velcro) Closures

(Offset for  
illustration )

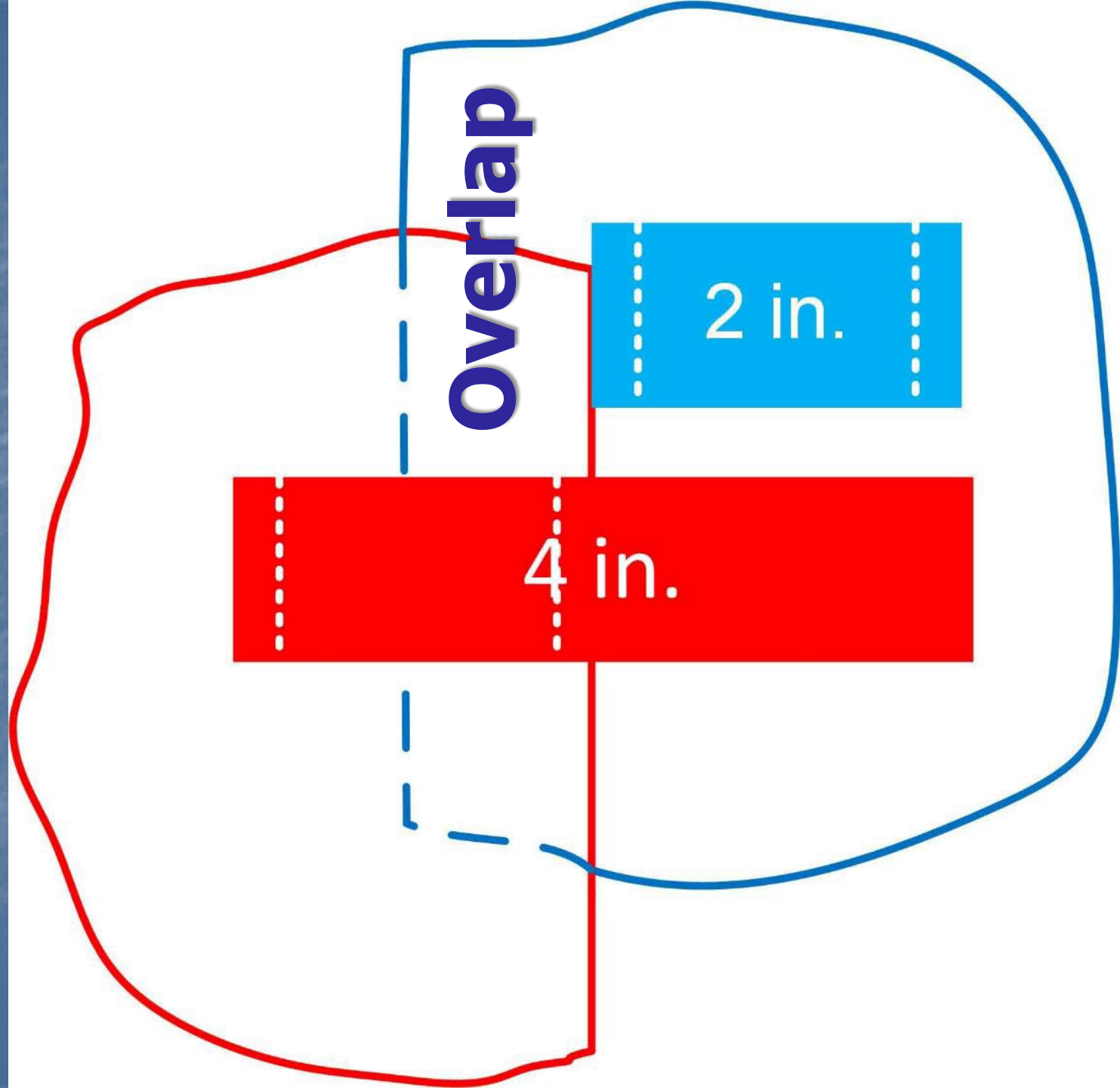

# Finished Casing

10 one inch  
hook and loop  
closures

fabric overlaps

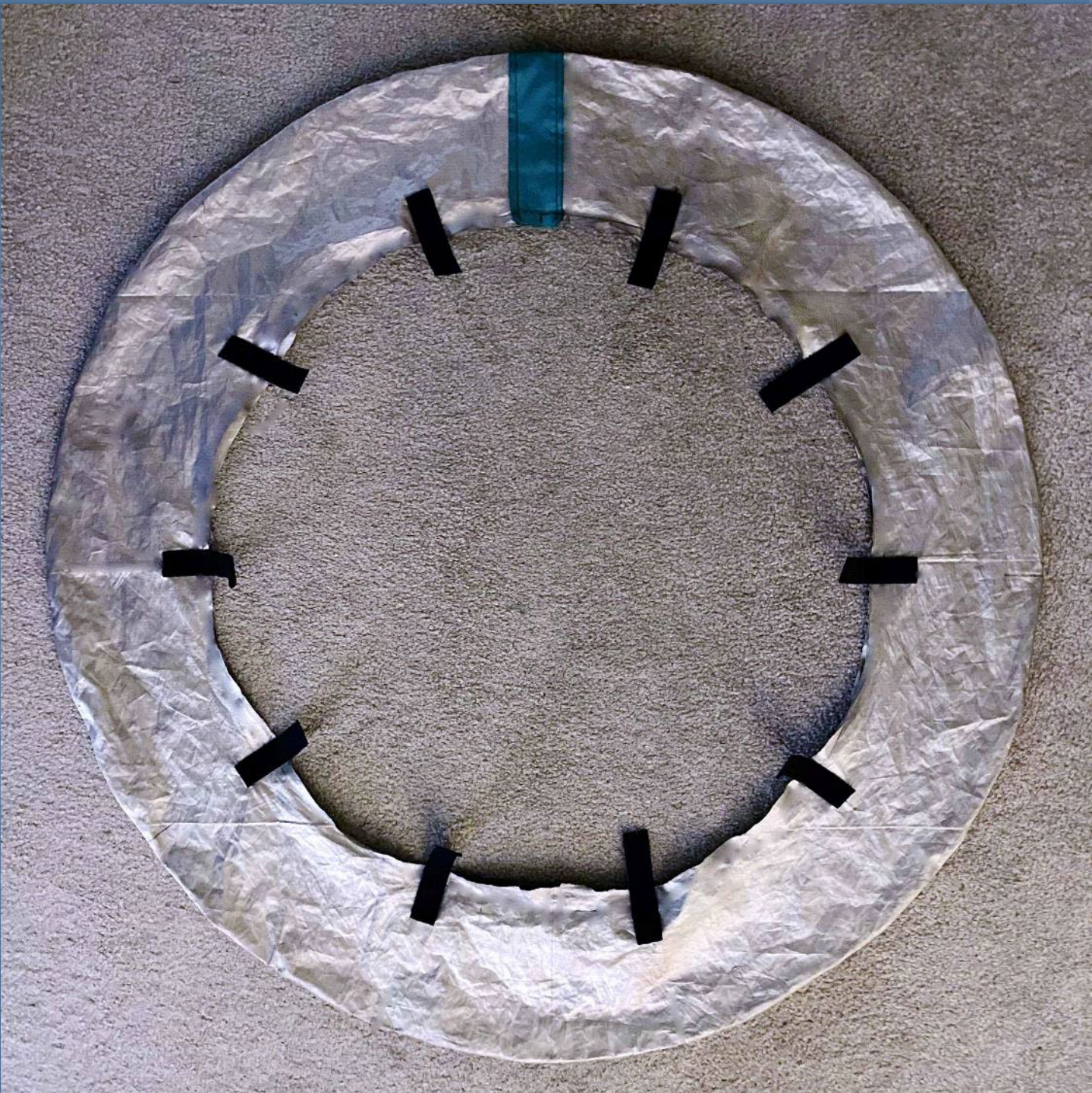

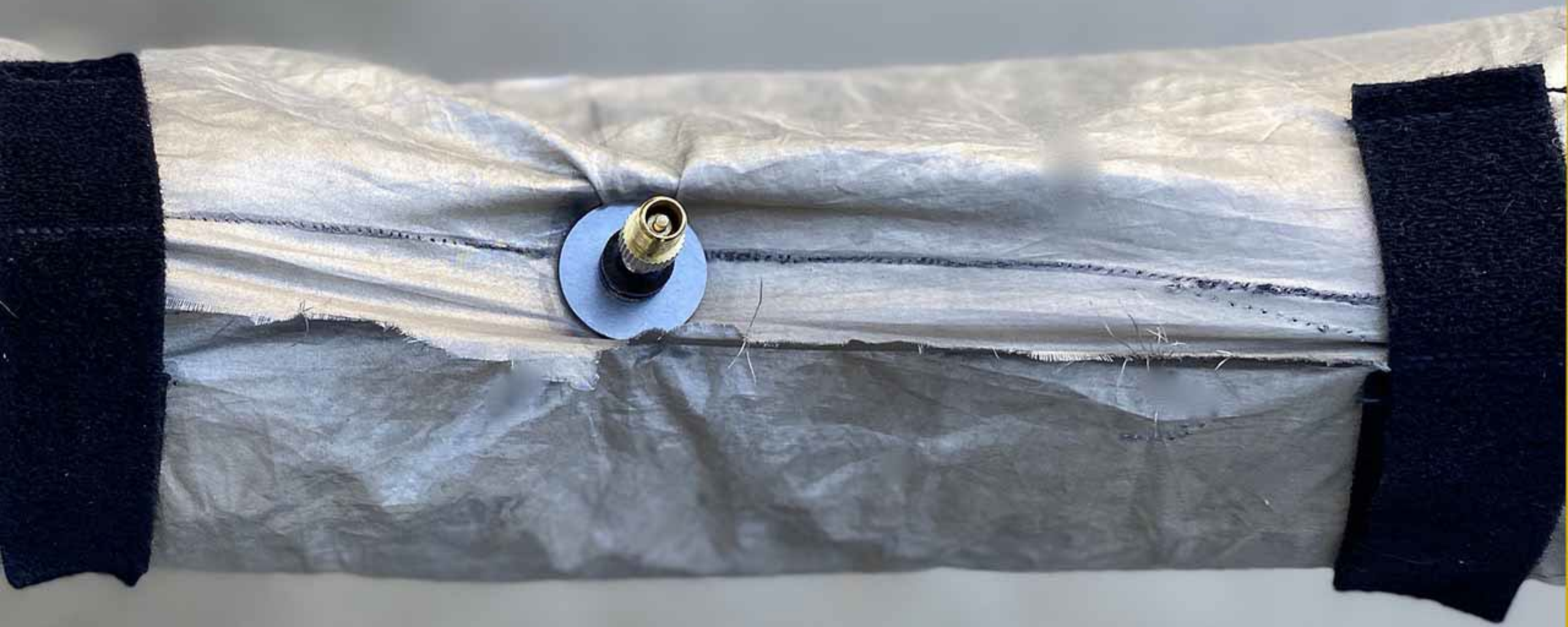



**Completed  
Inflated  
Loop with  
Coupling Loop  
and Tuning  
Capacitor(s)**

# Coupling Loop

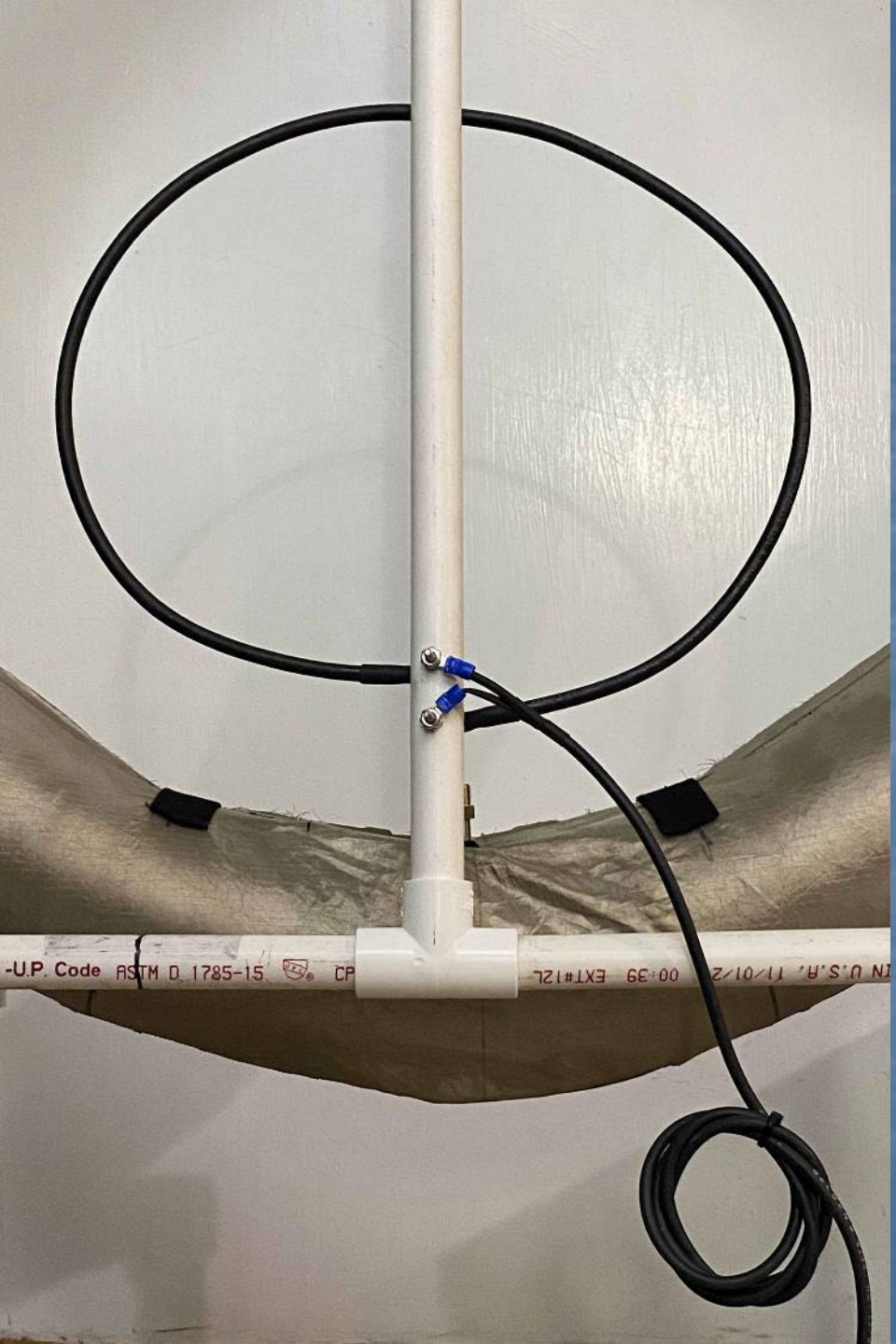

# Traditional 1/5 Dia. Separate Coupling Loop

RF Transformer

# Tuning Capacitor [S]

# Band Tuning

**High Voltage  
Disc Ceramic  
Capacitors**

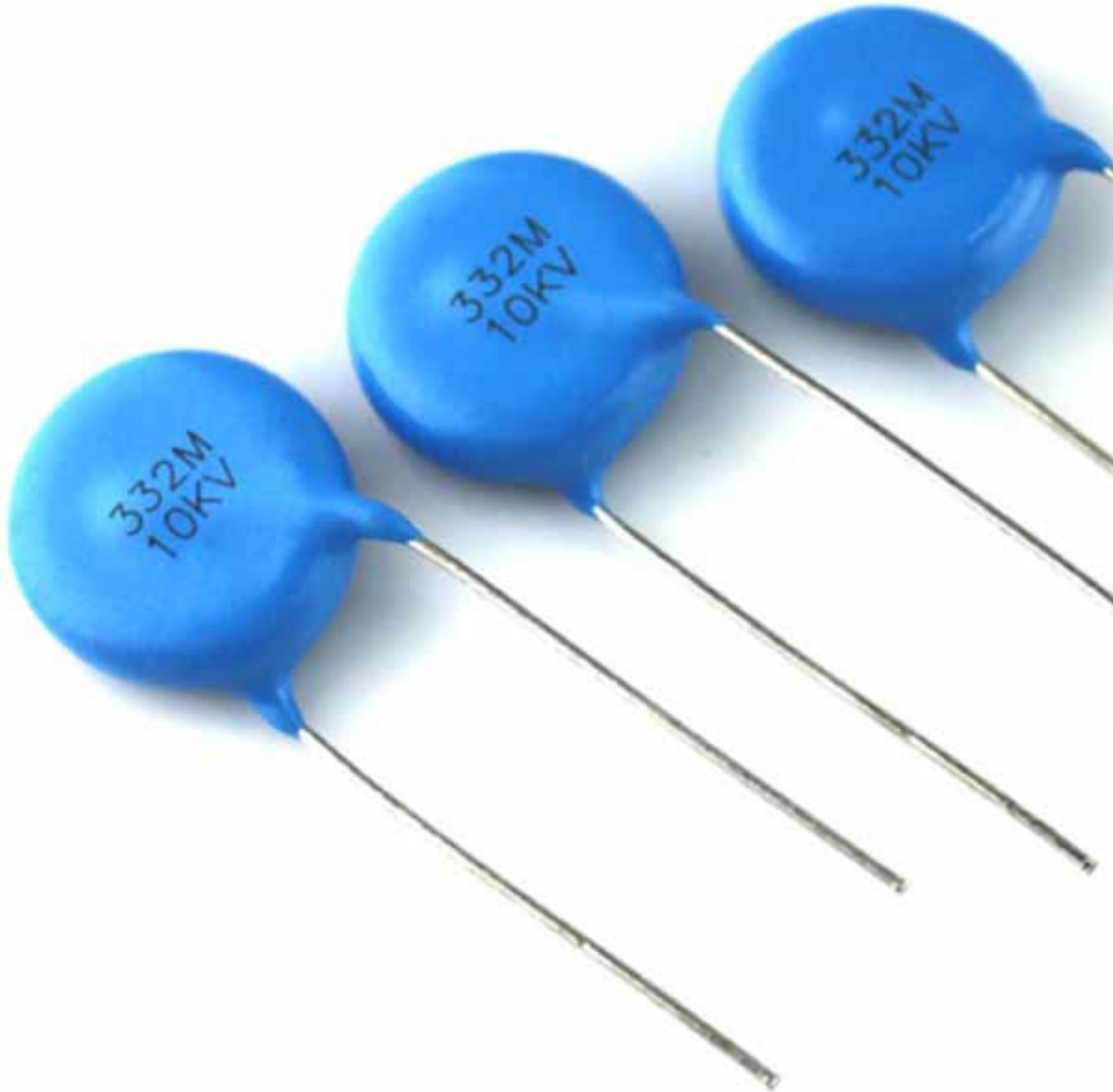



# Band Tuning – 1 set/band

<http://www.iw5edi.com/software/magnetic-loop-calculator>

MHz	Cap. pf
1.8	5993
3.5	1385
7	339
14	79
21	30
28	13

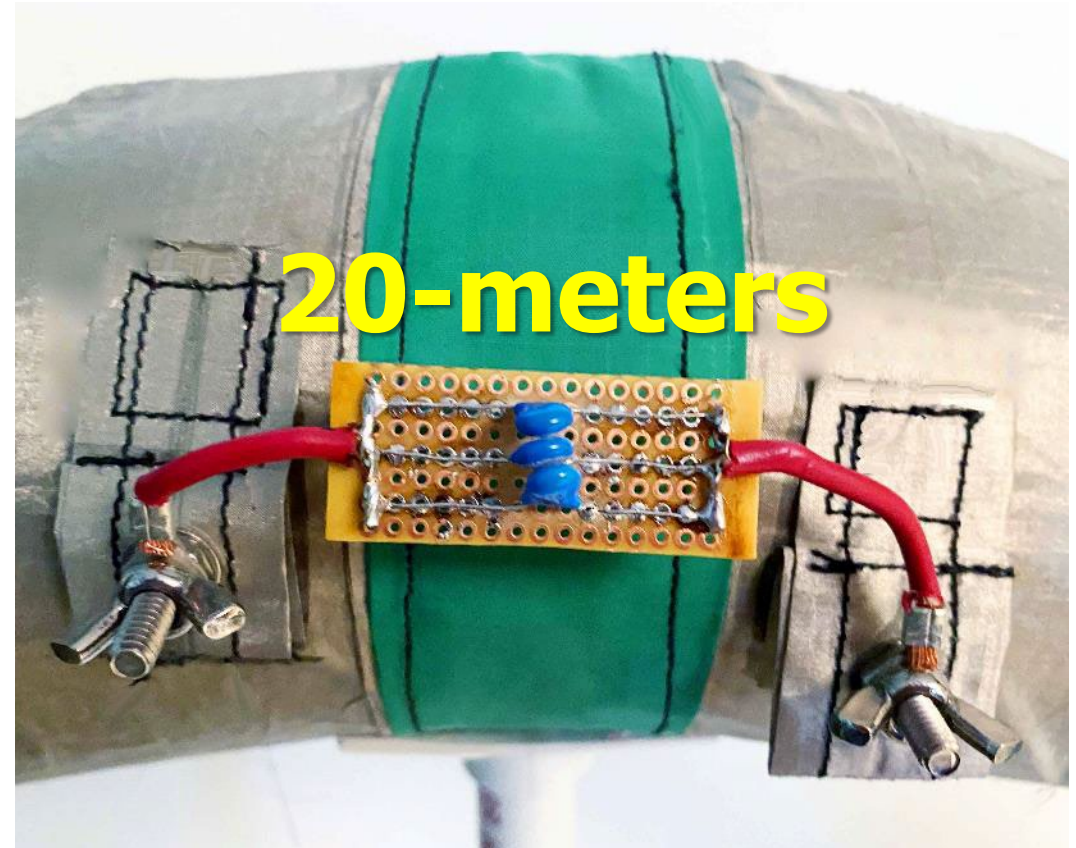

**2-3 KV**

**GAP**

**Linear fine  
tuning capacitor**

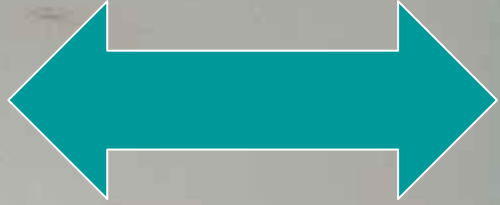

**Band capacitor**

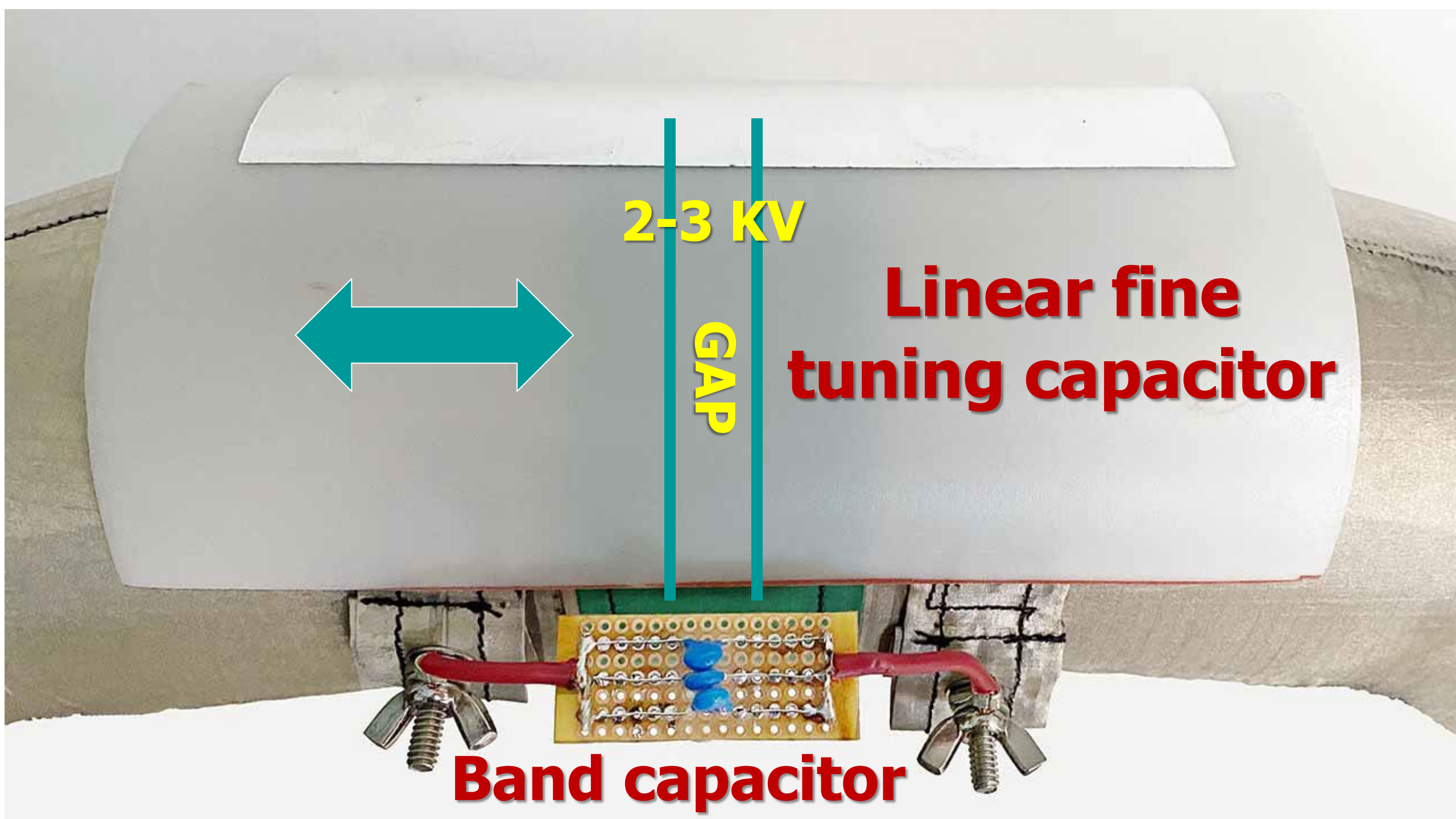

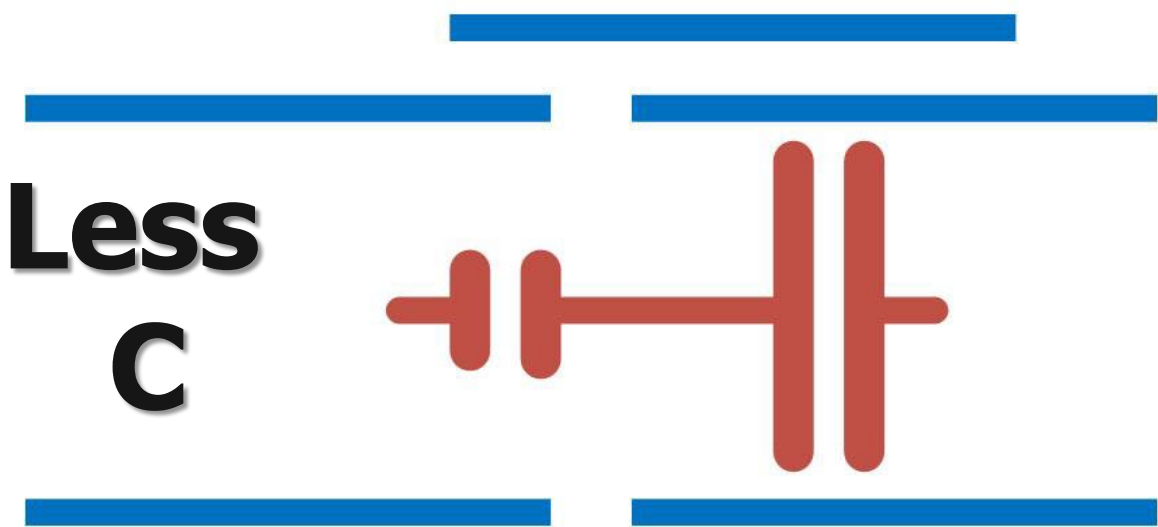
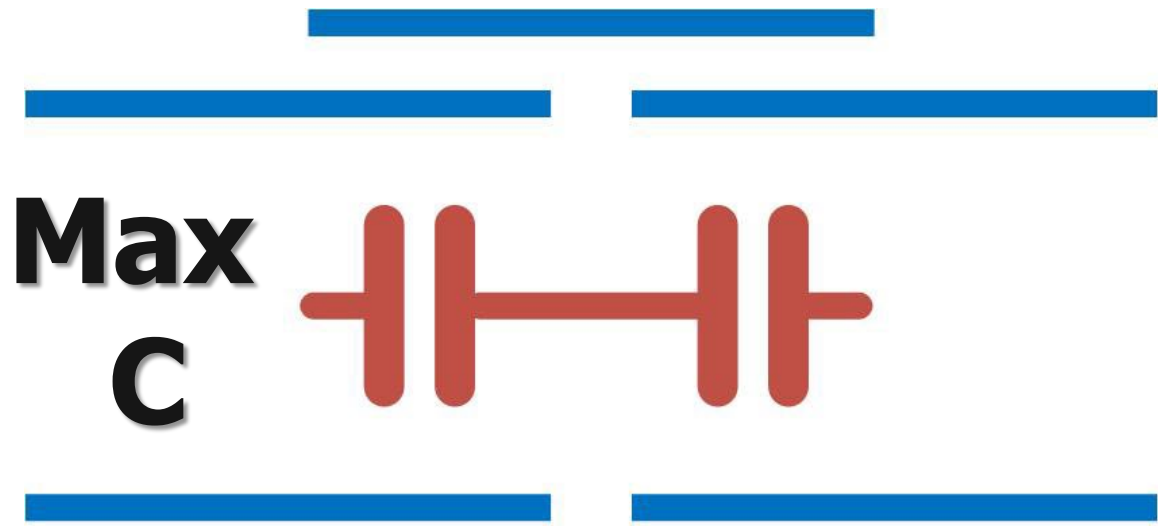

**Linear  
Capacitor**

**Two  
capacitors  
in series**

# Radiation and Gain EZNEC Pro/4+

Total Field

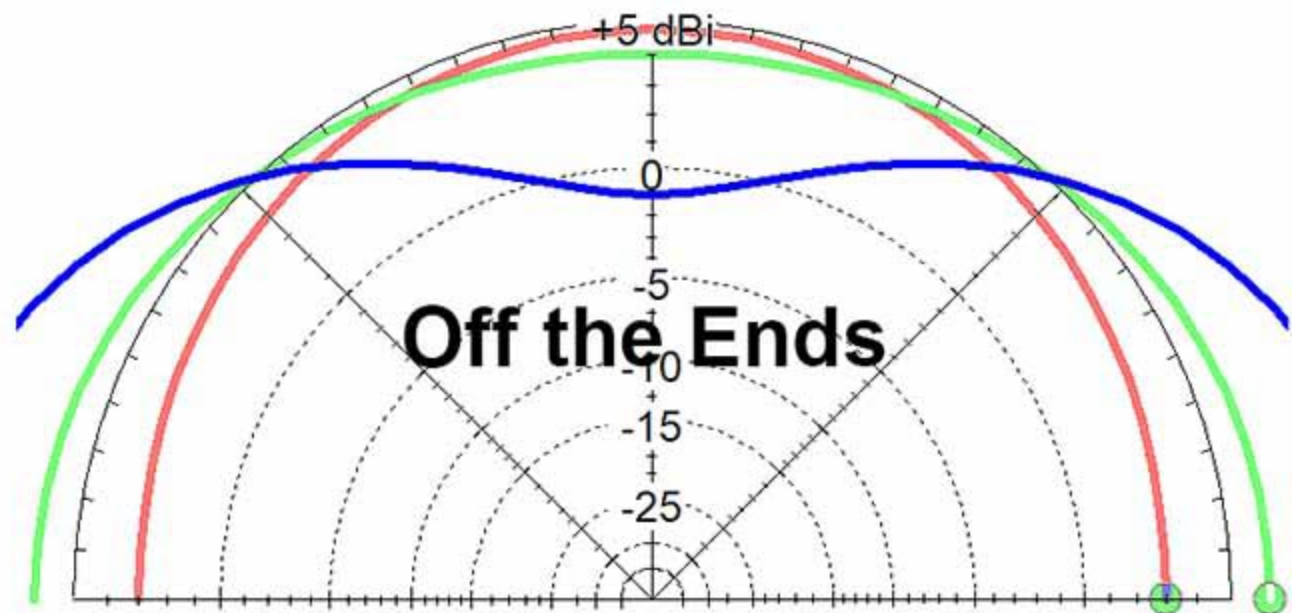
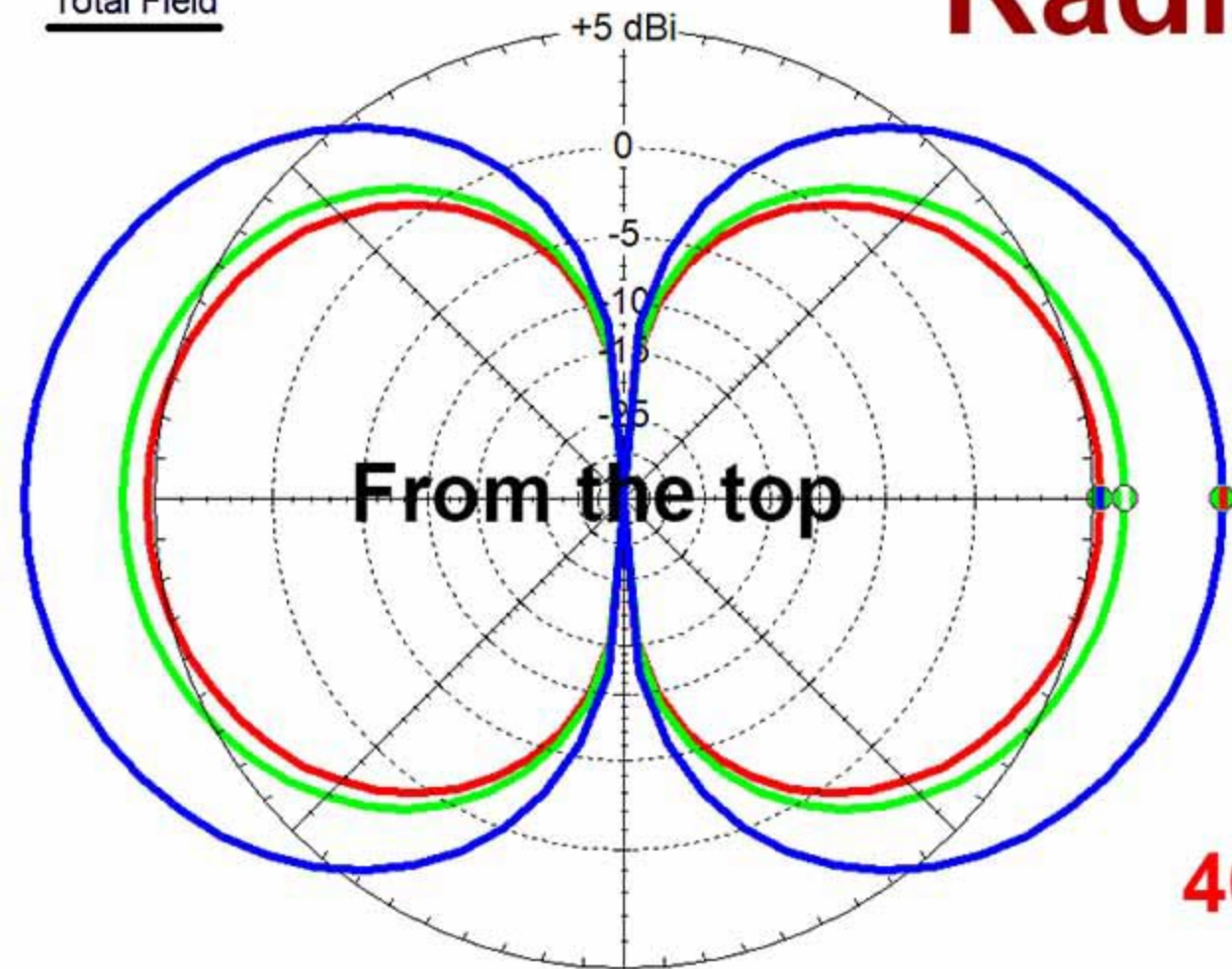

**40-meters** **20-meters** **10-meters**

***AGAIN – This loop is an unfinished experiment***

***I DON'T HAVE BUILD-IT PLANS***

***Many details are still to be worked out***

***I do, therefore, want your suggestions***

***w6nbcmail@gmail.com***

***Power Point Slides: [w6nbc.com/slides](http://w6nbc.com/slides)***



***Pool  
Backwash  
Tubing***



***Heat  
Shrink  
Tubing***



***Pool  
Noodles***

*Who says conductive fabric antennas are a bad idea?*

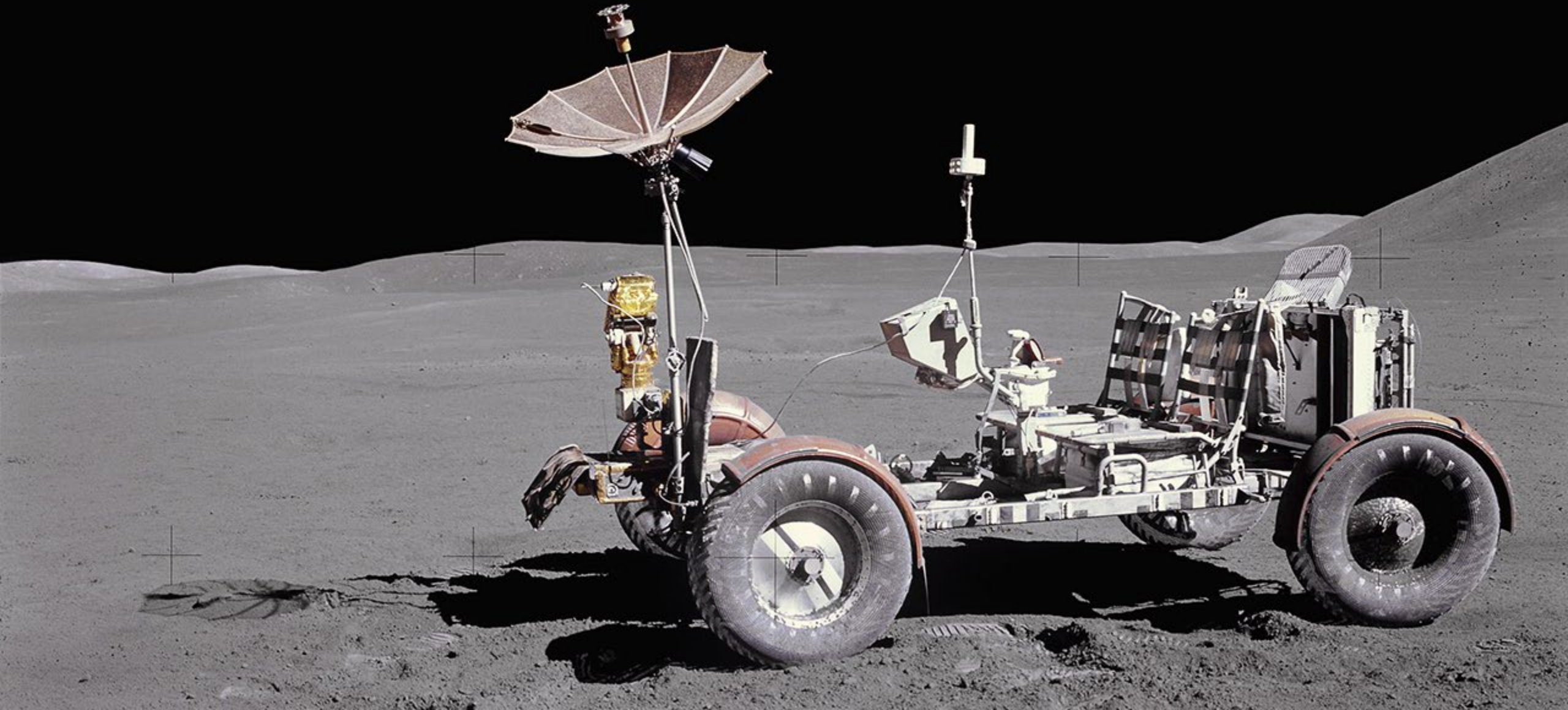



March 24-26 2023

## Questions and Answers

*Beginning now*

**Power Point slides  
[w6nbc.com/slides](http://w6nbc.com/slides)**

**Email: [w6nbcmail@gmail.com](mailto:w6nbcmail@gmail.com)**